

MBN 枠

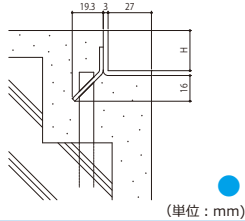
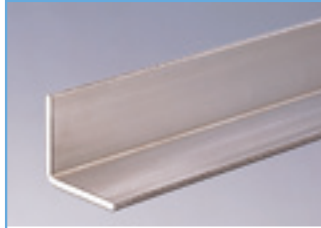

(単位: mm)

アン グ ル サ イ ズ	15H 用	L3 × 18 × 30
	20H 用	L3 × 23 × 30
	25H 用	L3 × 28 × 30
	32H 用	L3 × 35 × 30
	38H 用	L3 × 41 × 30

MBN-Q 枠 (クッションゴム付)

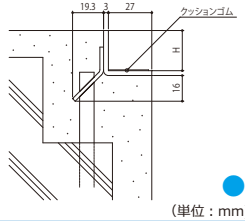
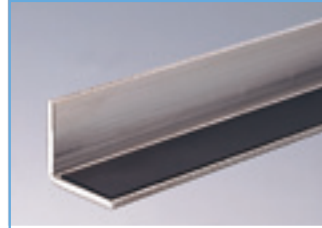

(単位: mm)

アン グ ル サ イ ズ	15H 用	L3 × 18 × 30
	20H 用	L3 × 23 × 30
	25H 用	L3 × 28 × 30
	32H 用	L3 × 35 × 30
	38H 用	L3 × 41 × 30

B 枠

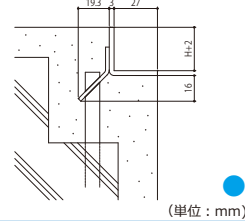

(単位: mm)

アン グ ル サ イ ズ	15H 用	L3 × 20 × 20
	20H 用	L3 × 25 × 25
	25H 用	L3 × 30 × 30

B-Q 枠 (クッションゴム付)

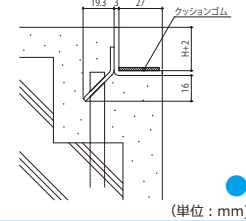
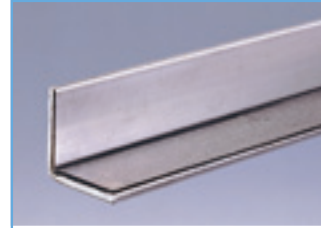

(単位: mm)

アン グ ル サ イ ズ	15H 用	L3 × 20 × 20
	20H 用	L3 × 25 × 25
	25H 用	L3 × 30 × 30

G-Q 枠 (クッションゴム付)

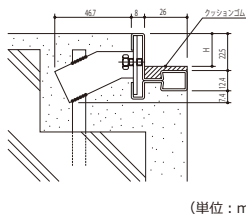
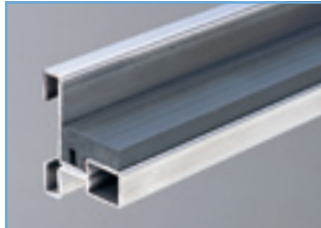

(単位: mm)

H	15H 用
	20H 用

APF-I-25 枠 (クッションゴム付)

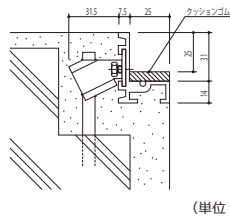
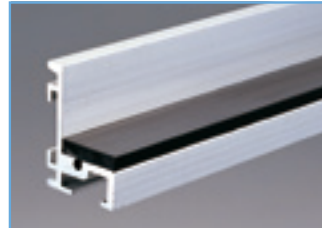

(単位: mm)

H	25H 用
---	-------

APF-Ⅲ 枠

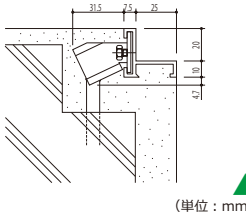

(単位: mm)

H	20H 用
---	-------

APF-I-30 枠

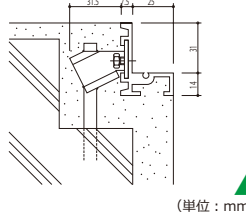

(単位: mm)

H	30H 用
---	-------

納まり図

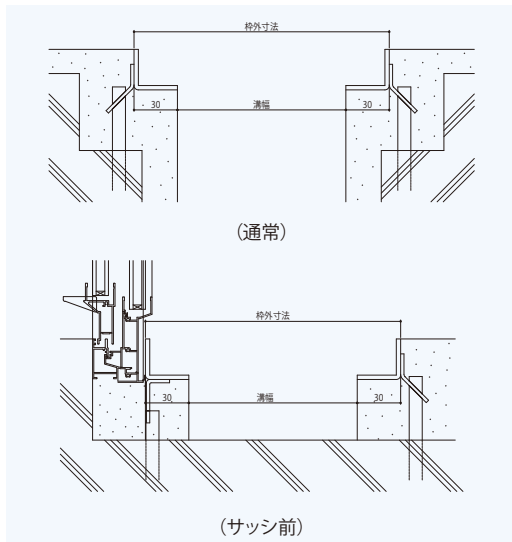

中間受材 (脱着式)

